



Handling System for Pot & Pans Pre-wash/Unloading Table with Grid Undershelf, 900mm

ITEM # _____

MODEL # _____

NAME # _____

SIS # _____

AIA # _____

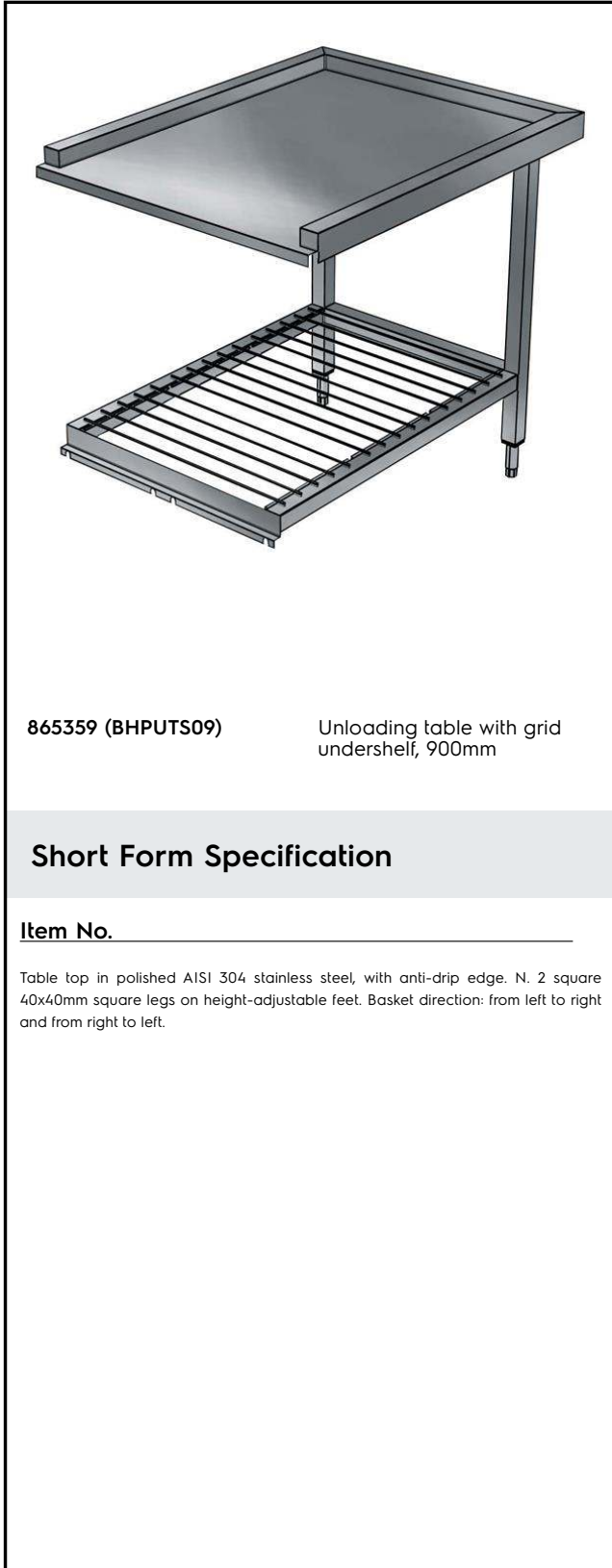

865359 (BHPUTS09)

Unloading table with grid
undershelf, 900mm

Short Form Specification

Item No. _____

Table top in polished AISI 304 stainless steel, with anti-drip edge. N. 2 square 40x40mm square legs on height-adjustable feet. Basket direction: from left to right and from right to left.

Main Features

- Supplied knocked-down and easy to assemble.

Construction

- 304 AISI stainless steel construction throughout.
- To be secured to the dishwasher and fitted with one pair of legs at the other end.
- Unloading tables equipped with grid shelf.
- All surfaces smooth with polished finish.
- Stainless steel square 40x40mm tubular legs.
- Deep anti-drip profiles completely folded with lower edge for safe and easy cleaning.

Optional Accessories

- Floor fastening kit for 2 square legs PNC 865386
- Undershelf for Pot and Pan Washer table, 900 mm PNC 865387

APPROVAL: _____



Experience the Excellence
www.electroluxprofessional.com

Front

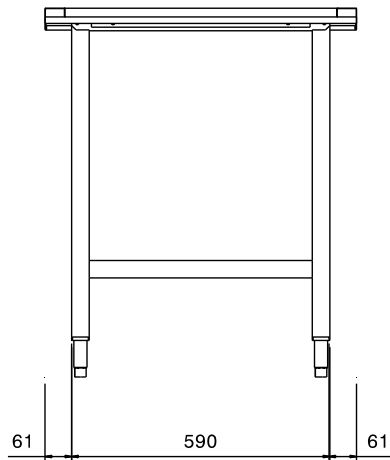

Side

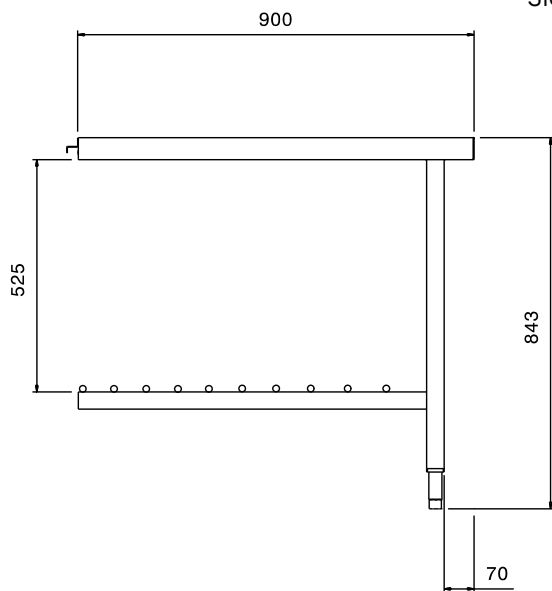

Top

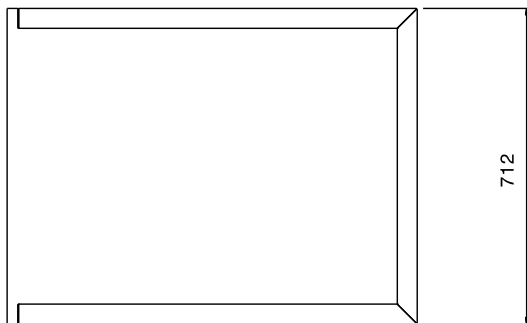

Key Information:

External dimensions, Width:	
865359 (BHPUTS09)	900 mm
External dimensions, Depth:	712 mm
External dimensions, Height:	843 mm
Net weight:	8 kg